

International Conference on Space Optics—ICSO 2004

Toulouse, France

30 March–2 April 2004

Edited by Josiane Costeraste and Errico Armandillo



Lidar instruments for ESA Earth observation missions

*Arnaud Hélière, Errico Armandillo, Yannig Durand,
Alain Culoma, et al.*



International Conference on Space Optics — ICSO 2004, edited by Errico Armandillo,
Josiane Costeraste, Proc. of SPIE Vol. 10568, 1056801 · © 2004 ESA and CNES
CCC code: 0277-786X/17/\$18 · doi: 10.1117/12.2308005

LIDAR INSTRUMENTS FOR ESA EARTH OBSERVATION MISSIONS

Arnaud Hélière, Errico Armandillo, Yannig Durand, Alain Culoma, Roland Meynard

*European Space Agency, Directorate of Earth Observation Programmes
P.O. Box 299, 2200 AG Noordwijk, The Netherlands. Email: www.esa.int*

ABSTRACT

The idea of deploying a lidar system on an Earth-orbiting satellite stems from the need for continuously providing profiles of our atmospheric structure with high accuracy and resolution and global coverage. Interest in this information for climatology, meteorology and the atmospheric sciences in general is huge. Areas of application range from the determination of global warming and greenhouse effects, to monitoring the transport and accumulation of pollutants in the different atmospheric regions (such as the recent fires in Southeast Asia), to the assessment of the largely unknown microphysical properties and the structural dynamics of the atmosphere itself.

Spaceborne lidar systems have been the subject of extensive investigations by the European Space Agency since mid 1970's, resulting in mission and instrument concepts, such as ATLID, the cloud backscatter lidar payload of the EarthCARE mission, ALADIN, the Doppler wind lidar of the Atmospheric Dynamics Mission (ADM) and more recently a water vapour Differential Absorption Lidar considered for the WALES mission. These studies have shown the basic scientific and technical feasibility of spaceborne lidars, but they have also demonstrated their complexity from the instrument viewpoint. As a result, the Agency undertook technology development in order to strengthen the instrument maturity. This is the case for ATLID, which benefited from a decade of technology development and supporting studies and is now studied in the frame of the EarthCARE mission. ALADIN, a Direct Detection Doppler Wind Lidar operating in the Ultra-Violet, will be the 1st European lidar to fly in 2007 as payload of the Earth Explorer Core Mission ADM. WALES currently studied at the level of a phase A, is based upon a lidar operating at 4 wavelengths in near infrared and aims to profile the water vapour in the lower part of the atmosphere with high accuracy and low bias. Lastly, the European Space Agency is extending the lidar instrument field for Earth Observation by initiating feasibility studies of a spaceborne concept to monitor atmospheric CO₂ and other greenhouse gases.

The purpose of this paper is to present the instruments concept and related technology/instrument developments that are currently running at the European Space Agency. The paper will also outline the development planning proposed for future lidar systems.

1. INTRODUCTION

Lidar systems offer a wide range of capabilities for the remote detection and monitoring from space of the atmosphere and its constituents as well as for the measurement of certain land or sea surface parameters.

Therefore, the development of advanced lidar systems for space applications and their evaluation by airborne or ground based test campaigns is considered an important strategic element of the Agency's Earth Observation Programme.

ESA has been supporting the development of laser systems for remote sensing since the early eighties. By exploiting various properties of the interaction between the signal and the matter, surface, atmosphere, dedicated target, observations can be performed that are of relevance for various Earth Science disciplines and applications.

The Atmospheric Lidar (ATLID) measures the signal backscattered by clouds and aerosols to determine essential data for the study of the Earth radiation budget, its distribution and divergence. It is considered candidate for flight on the former named ERM mission (Earth Radiation Mission), now called EarthCARE. A similar sensor will be launched on the Calipso/CENA mission of NASA and CNES. Even if not selected for flight yet, the technology development for ATLID has been essential for other missions such as ADM-Aeolus and in general for European efforts on lidars.

The ALADIN Lidar for the Atmospheric Dynamics Mission provides direct observation of wind profiles by measuring the Doppler shift induced by the motion of molecules and aerosols. ALADIN is under development for launch in 2007 onboard the ADM-Aeolus satellite. The usefulness of ALADIN data for NWP makes it a promising candidate for continuation in follow-on rugged operational systems.

Studies of an Ice Topography Observing System, using a laser altimeter early considered for implementation on the Topography Earth Explorer mission, was later abandoned in favour of microwave option (Cryosat) for the better performance of the latter and in view of NASA's selection of GLAS for Icesat.

The sounding of atmospheric composition with active techniques has been considered in the past especially for water vapour and to lesser extent in Europe for ozone. A

mission concept, WALES, is being considered as candidate Earth Explorer Core Mission. Other concepts had been proposed, including proposals to ESA, like the Carosat proposal to the second cycle of Earth Explorer Core Missions, featuring a DIAL for derivation of profiles of CO₂ concentration.

It is expected that the measurement capabilities of DIAL lidars and similar differential spectroscopy laser instruments, will attract more and more interest from the scientific community, resulting in new upcoming missions proposals.

2. AEOLUS

AEOLUS has been selected for implementation as the second core mission of the Earth Explorer Core missions of ESA's Living Planet programme. It is scheduled for launch in 2007, for a three-year mission, to study the Atmospheric Dynamics. Aeolus will provide measurements of tropospheric wind profiles on a global scale, with accuracy of 1m/s below 2 km and 2 m/s above 2 km.

The core space element of ADM-AEOLUS is ALADIN (Atmospheric Laser Doppler Instrument), a direct detection Doppler Wind Lidar (DWL) incorporating a fringe-imaging receiver (analyzing aerosol and cloud

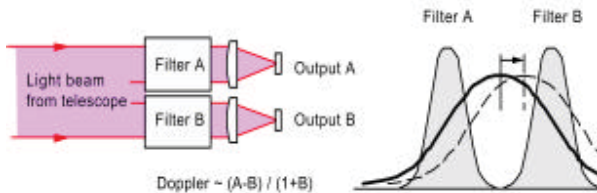

Figure 1: Double-edge technique: The filter output signals A and B are used as the ratio between the difference and the sum to estimate the Doppler shifts.

backscatter) and a double-edge receiver (analyzing molecular backscatter). The instrument sends a high energy laser pulse at 355 nm towards the atmosphere, which is backscattered by aerosol particles (Mie scattering) and molecules (Rayleigh scattering). The frequency Doppler-shifted backscattered signal is analyzed through the high-resolution spectrometer and by direct detection techniques.

The Lidar functional architecture is organized in four main functions: the Transmitter, the transmit/receive Telescope, the Receiver, and the ACDM (Aladin Control and Data Management).

The transmitter assembly is based on a diode-pumped tripled Nd:Yag laser emitting 150mJ pulsed energy at 355 nm. It will be operated in burst mode with 100 Hz PRF during 7 second, every 28 seconds. There are two fully redundant transmitters, each including two laser heads (Power Laser Head, and Reference Laser Head) and a transmitter laser electronic (TLE).

The Telescope is an afocal Cassegrain with 1.5 m entrance pupil. All-SiC construction is proposed for the mirrors and the M1-M2 tripod link, mainly motivated by consideration of mass saving and geometrical stability.

The receiver assembly includes the transmit/receive switch (polarization-based), a set of relay optics and diplexers for beam transports and laser reference calibration, a blocking interference filter, the Mie and Rayleigh spectrometers, the two Detection Front-end Units (DFUs). Both spectrometers are used in conjunction with a thinned back-illuminated Si-CCD detector working in an accumulation mode (Astrium patent), which allows photon counting and provides very high quantum efficiency.

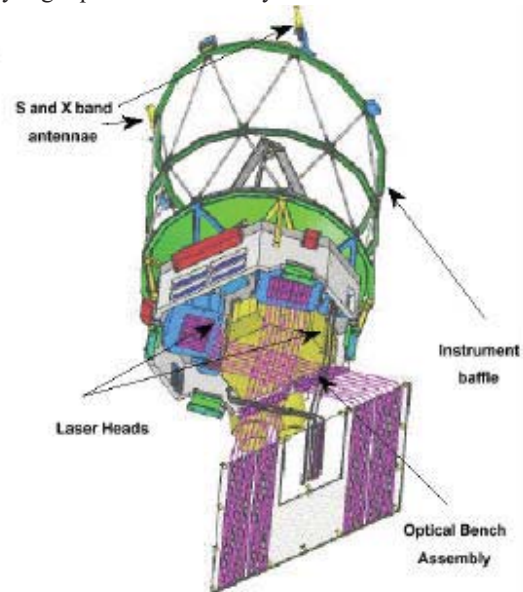

Figure 2: Aladin instrument architecture

3. EarthCARE

The **Earth Clouds, Aerosols and Radiation Explorer** mission has been proposed as a candidate for the future Earth Explorer Core missions of ESA's Living Planet programme. The mission major objective is to determine, in a radiatively consistent manner, the global distribution of vertical profiles of cloud and aerosol field characteristics. The EarthCARE payload is composed of four instruments: an Atmospheric backscatter Lidar (ATLID), a Cloud Profiling Radar (CPR), a Multi-Spectral Imager (MSI) and a Broad Band Radiometer (BBR).

ATLID will provide vertical profiles of the physical parameters of aerosols (e.g. optical depth), and the altitude of the highest cloud top. The requirements applicable to ATLID are presented in table 1. A single wavelength (355 nm) lidar with High-Spectral Resolution receiver separating Rayleigh (molecular) and Mie (cloud and aerosol particles) backscattered has been selected as baseline.

Table 1: ATLID observation requirements

	Mie co-polar channel	Rayleigh channel	Mie cross-polar channel
Cirrus optical depth	0.04		
Backscatter $\text{sr}^{-1} \text{m}^{-1}$	$8 \cdot 10^{-7}$		$2.6 \cdot 10^{-5}$
Vertical resolution	100 m	300 m	100 m
Horizontal resolution	10 km		
Required Accuracy	50%	15%	50%

This wavelength allows relatively high pulse energy to be used without infringing on eye safety. A small footprint of around 20 m is favoured to minimise the multiple scattering effects and reduce the solar background noise by reducing the telescope field of view. An additional cross-polarisation channel is implemented.

Instrument concept

The agency conducted two phase A's under prime responsibility of ALCATEL space and ASTRUM to study both mission and instrument concepts.

ATLID laser concept is a diode-pumped frequency tripled Nd:YAG similar to ALADIN with reduced requirements, as the energy required is 20-25mJ with a pulse repetition frequency of 70-100Hz. Operations during daylight are made possible thanks to a filter train, interference filter plus etalons, reducing drastically the background level.

The Rayleigh and Mie backscatter separation is obtained at receiver level thanks to a single narrow bandwidth (spectral bandwidth 0.2 to 0.5pm) etalon, so-called the High Spectral Resolution etalon, featuring high peak transmission. The working principle of the

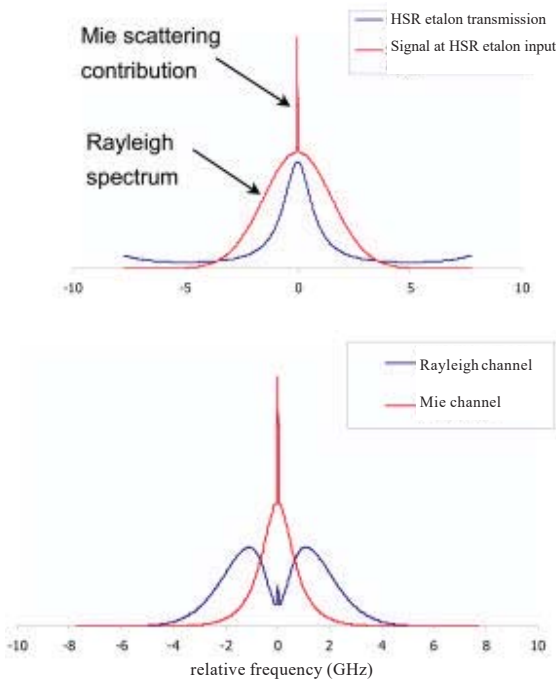

Figure 3: Backscattered signal spectral distribution (a)
Transmitted and reflected signals by the HSR etalon (b)

receiver detection is depicted in Figure 3.

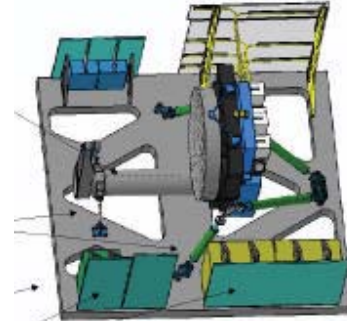

Figure 4: ATLID instrument architecture as proposed by one of the phase A

4. WALES

The **W**ater vapour **L**idar **E**xperiment in **S**pace mission has been proposed as a candidate for the future Earth Explorer Core missions of ESA's Living Planet programme. The mission is to provide improved insights into the distribution of atmospheric water vapour and information on aerosols in the troposphere and lower stratosphere relevant to climate change studies, atmospheric modelling and chemistry studies and to numerical weather forecasting. It is a single payload mission operating a nadir viewing Differential Absorption Lidar (DIAL) instrument.

The measurement requirements for WALES are presented in table2. Direct detection DIAL operated in the 935 nm spectral range is the most suitable concept to provide low statistical errors and bias.

Table 2: WALES observation requirements

	PBL	Low Troposphere	High Troposphere	Low Stratosphere
Vertical domain	0-2km	0-5 km	5-10 km	10-16 km
Vertical resolution	1 km			2 km
Horizontal resolution	25km	100 km	150 km	200 km
Dynamic range	0.01-15 g/kg			
Random error	< 20 %			
Bias	< 5%			

The DIAL technique compares the attenuation of two laser pulses emitted at different wavelength. The on-line wavelength falls on the centre of a water vapour absorption line and the off-line wavelength falls on the line wing, where absorption is significantly reduced.

The large dynamic range of water vapour is addressed with a DIAL instrument by using different on-line wavelengths $\lambda_1, \lambda_2, \lambda_3$ with different (water vapour) attenuation cross-sections, and one off-line wavelength λ_4 , as depicted in Figure 5.

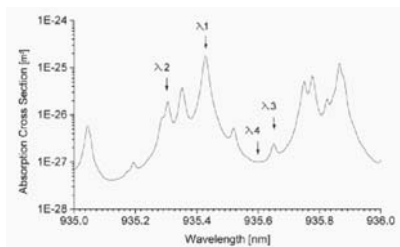

Figure 5: Selected water vapour lines for WALES

The different on-line wavelengths possess different penetration depths, thus allowing for measurements in different altitude intervals.

The strongly absorbing water vapour lines are used for higher altitudes and the weakly absorbing lines are used for lower altitudes (high water vapour concentration).

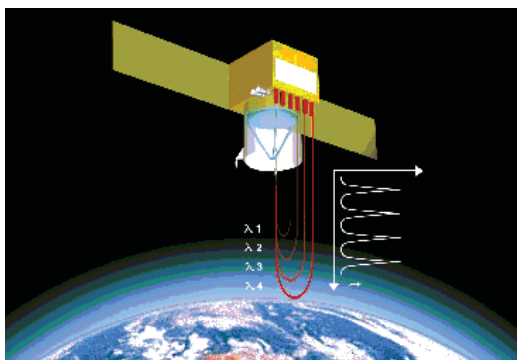

Figure 6: Observational principle of WALES

Instrument concept

The agency conducted two phase A's under prime responsibility of ALCATEL Space and ASTRIUM ltd. to study mission and instrument concepts. These studies are now completed. Two instrument concepts have been proposed and are both based on the emission of 4 wavelengths, serving as 3 pairs of on- and off-line wavelengths. They are depicted in figure 7. The main subsystems are:

- 2 transmitter units capable of emitting 2 wavelengths each, plus one unit in cold redundancy,
- Separate telescopes to transmit the different wavelengths,
- One or three large telescope providing a collection aperture of 2 to 3m²,
- Four direct detection receivers with blocking filters to reduce the background noise level,
- Instrument control electronics. The instrument provides 50 m vertical sampling from ground to 16 km altitude and less than 1 km horizontal sampling.

Two different emission and measurement modes were proposed, the burst mode where the 4 wavelengths are

emitted in a cascade way with a time separation of 100μs and a continuous mode where wavelengths are emitted each 10ms but with different line of sight directions to allow sampling of the same atmospheric volume by the 4 emitted wavelengths. This last operation mode features advantageous receiving concept by in-field separation but requires sophisticated active alignment and satellite pointing.

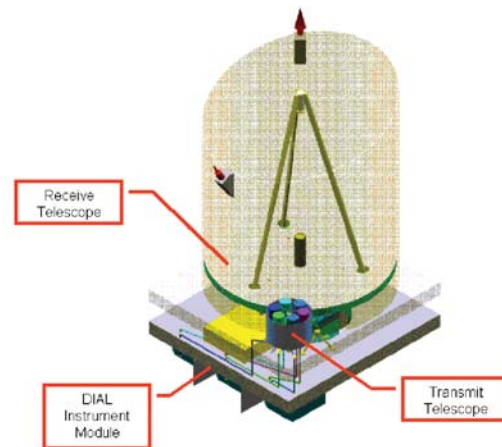
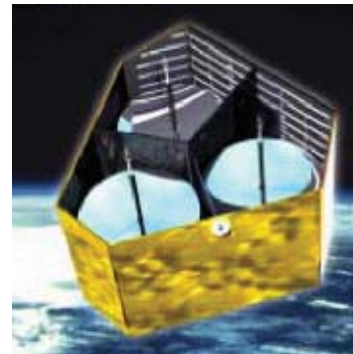

Figure 7: WALES payload modules as resulting from the two phase A

Transmitter system

The DIAL measurement principle does not require radiometric calibration. However, accurate control of the transmitted wavelengths is required. Knowledge of both the absolute wavelength and the transmitter spectral shape determines the achievable systematic measurement error (bias). The requirements applicable to the laser system are given in the table 3.

The transmitter system is made of 3 identical units each emitting 2 wavelengths, one unit being implemented in cold redundancy. A transmitter unit consists of 2 elements, the pump unit and the laser source. The pump unit is a frequency doubled Nd:YAG laser operating at 532nm emitting pulses of 300-350mJ and could re-use most of ALADIN laser developments.

Table 3: Requirements applicable to the laser system

Number of wavelengths	4 wavelengths to be transmitted as a burst of 4 pulses
Laser pulse energy	75 mJ
Pulse repetition frequency (double pulse)	25 Hz
Inter pulse separation within burst	200 μ s
Wavelength range	935 nm
Laser frequency accuracy and stability	< 60 MHz
Laser linewidth	<160 MHz
Laser spectral purity within 1GHz	>99.9 %

The pump pulses are routed to one of the two independent laser sources; Ti:Sapphire laser has been identified as promising candidate to provide high spectral purity and high pulse energy in the 920-950nm band.

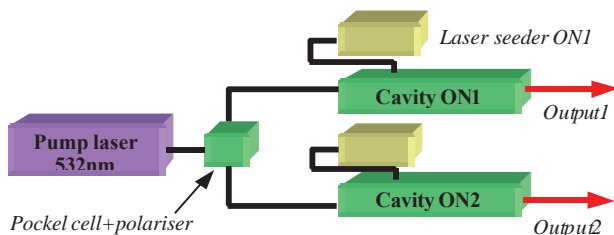

Figure 8: Transmitter unit concept

In addition, to ensure high spectral purity, the laser source must be injected with a laser seeder based on external cavity diode laser or a DFB/DBR diode laser. The long-term frequency stabilisation can be achieved by using water vapour cells and wavemeters.

Receiver system

The receiver concept consists of a large aperture telescope, a spectral pre-selection unit and four receiver channels, each including a high resolution spectral filter stage and a detector assembly. Two concepts were proposed for the telescope, a single aperture of 1.75m diameter and a tri-pupil concept of an equivalent 2.1m diameter.

The narrow bandwidth etalon (~40 pm bandwidth) is a key element in the receiver chain to separate any particular wavelength and block the background radiation. The detector could consist of Avalanche Photo Diode providing both high efficiency and low noise in the required spectral band, an alternative solution is the newly developed L3CCD from E2V Technology that provides photon-counting capabilities.

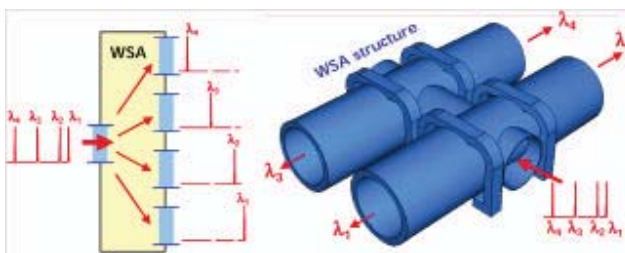

Figure 9: Wavelength separator assembly as proposed in one of the receiver concept

5. Lidar Technologies and instrument pre-developments

ALADIN Pre-Development Model

Following the selection for implementation of the ADM/Aeolus mission and the development risk analysis performed during phase A, a pre-development programme for the ALADIN instrument was undertaken to reduce the technical and programmatic risks of the mission. The objectives of this pre-development programme are to validate the technologies used in the flight design, evaluate the flight-worthiness of its major equipment and critical component and verify the overall instrument performance. The pre-development programme encompasses:

- a) A laser transmitter programme, including
 - Two parallel developments of laser breadboards to demonstrate the feasibility of a diode-pumped frequency tripled Nd:YAG laser providing 150 mJ per pulse at 355 nm, operating in burst mode with 100 Hz PRF during 7 seconds, every 28 seconds.
 - Testing of commercial continuous laser diodes and commercial pulsed laser diode arrays used respectively for pumping the seeder, and the oscillator and the amplifier stages of the laser transmitter.
 - Separate studies of specific technology improvements (e.g. optimisation of frequency tripling efficiency, solid-state phase-conjugation mirrors)
- b) A lidar receiver programme, consisting of a full Pre-Development Model (PDM) of the receiving part of the instrument, in a system and sub-system configuration as representative as possible of the design, materials and building techniques of the flight model.

One of the laser breadboards is being reconditioned for integration with the PDM, to allow end-to-end test of the lidar system after completion of the performance tests of the optical receiver. The PDM will later be

refurbished as airborne lidar and be used in the preparation and validation of the Aeolus mission.

The PDM is a functional representative model of the receiver part of the ALADIN instrument, composed of engineering model units going from the receiver/transmitter optics to the detection chain. All the critical sub-units (optical bench, Mie and Rayleigh spectrometers, detection front end unit, accumulation CCD) have been manufactured and successfully characterized. Key receiver sub-systems architecture, as the high resolution spectrometers, are shown on figure 10 together with pictures of the developed units. The main characteristics of both spectrometers are also provided in table 4 and 5.

The PDM programme includes as well the design, manufacturing and test of the detection electronic unit at breadboard level (video chain, sequencer, and interfaces).

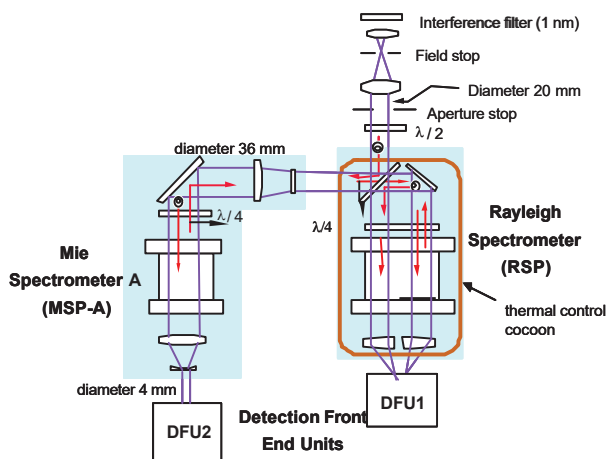

Mie spectrometer based on Fizeau design (left) and Rayleigh spectrometer based on double-edge (right)

Figure 10: Mie and Rayleigh receiver spectrometers

Table 4: Mie spectrometer characteristics

Design parameters	
Free spectral range	0.92pm
Useful spectral range	0.63pm
Peak transmission	70%
Resolution	0.056pm

Table 5: Rayleigh spectrometer characteristics

Design parameters	
Free spectral range	4.6pm
Peak spectral spacing	2.3pm
Peak transmission	80%
Resolution	0.76pm

After completion of the alignment of all units on the Optical Bench Assembly (OBA), the PDM has been submitted to environmental tests. First, thermal vacuum tests have been run to simulate the in-orbit environment, to simulate the performance range (+15 °C +25 °C) and the non-operating temperature (-20 °C +50 °C). Radiometric, spectral, geometrical, stability and thermal tests have been run. Second, the PDM has successfully passed mechanical tests at qualification levels for quasi-static (25 g), sine and random (5 g) tests for two axes, one of which was considered the most critical one. The results are in line with the flight model needs.

The full ALADIN PDM configuration consists of coupling the OBA with its detection electronics to the selected laser breadboard and associated electronics. A functional and performance test campaign will then be run on the full ALADIN PDM to conclude the assembly integration and verification of the ALADIN PDM. The results of these tests will demonstrate the validity of the design and the expected performance of the instrument. This is a key step in securing the path to the flight instrument.

Titanium Sapphire laser transmitter breadboard

The WALES laser transmitter has been identified as the most critical technology and ESA initiated in 2002 two contracts with ALCATEL space and Galileo Avionica for the development of this key component. Different technologies were traded in the frame of the contracts, namely: OPO, Ti:Sapphire and Raman lasers. Both contracts indicate the the Ti:Sa laser technology as the most mature and promising to fulfil both required power and spectral requirements.

The developed breadboards consist of a laser unit emitting two wavelengths in the 935-936nm spectral range as identified for WALES. The requirements applicable to the breadboard are those already mentioned in table 1.

The laser breadboard is made of high energy Ti:Sa oscillator pumped by a frequency doubled Nd:Yag together with two seeders stabilised on water vapour lines bringing the spectral quality. Alternatively, the Ti:Sa laser could be made of a low energy oscillator coupled with an amplifier.

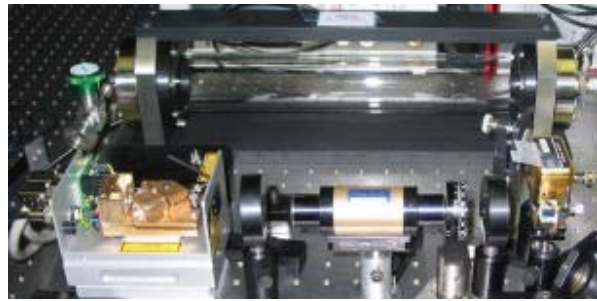

Figure 11: Frequency stabilised injection seeder

The transmitter breadboards are now being built; the injection seeder together with its stabilisation unit has already shown good performance meeting the requirements. First results for the injected laser should be available by April 2004.

Nd:Mixed Garnet laser transmitter breadboard

As part of the TRP, the agency has also initiated studies on solid-state laser technology known as Nd:Mixed Garnet laser in order to assess the suitability of the technology to provide multiple wavelength emission in the spectral domain identified for WALES. The technology has been recently the subject of intensive research and development in academia and industry. Two contracts involving Astrium GmbH with German research institutes and CESI have been started late 2002. The activity aims at developing the crystals and to build a high-energy breadboard laser. Radiation testing on crystals has already taken place and the studies should be completed by November 2004.

Development of a frequency stabilisation scheme

A key driver for the spectral performance of the laser is the injection seeder together with its frequency stabilisation insuring the long-term wavelength accuracy and stability required to emit in the water vapour absorption line. The overall frequency stabilisation unit is a complex sub-system requiring detailed studies and breadboard, as four stabilised wavelengths have to be provided to the WALES transmitter.

ESA is now running contracts, as part of the Technology and Research Programme, to breadboard a complete scheme for the stabilisation of 4 laser injection seeders under the prime responsibility of CSO-SAGEIS, Observatoire de Neuchatel and Intune Technologies. The activities will be completed by end 2004 and have already established a concept.

Development of high resolution optical filter technology

Narrow bandwidth optical filtering is a key element of many LIDAR instruments and is used to spectrally filter the incoming signal and reduce the intensity of background radiation. The objective of the work under

the prime contractor ship of AEA Technology together with Hovemere Ltd. is to develop the technology for a narrow bandwidth, high-resolution optical filter suitable for use in future LIDAR instruments, such as WALES.

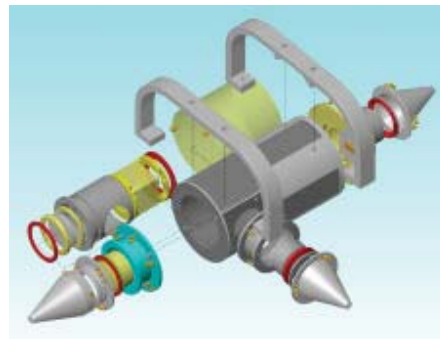

Figure 12: architecture proposed for the filtering stage

At the heart of the HRF design is a Capacitance Stabilised Fabry-Perot Etalon (CSE) that provides the narrow bandwidth spectral filtering. A key feature of the CSE is its ability to dynamically control the separation between the two étalon plates, allowing the filter to be tuned to different wavelengths and allowing the parallelism between the two plates to be accurately controlled. The CSE will have a tunable range of 9 nm.

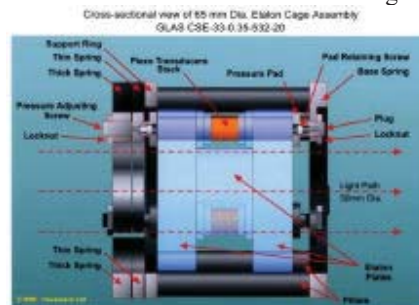

Figure 13: Capacitance Stabilised Etalon developed for GLAS

A schematic diagram of a Capacitance Stabilised Etalon, as used on a previous programme, is shown in Figure 13.

In order to obtain the high value of finesse necessary to achieve the narrow transmission bandwidth, considerable care is required in the manufacture of the étalon plates. In fact, achieving a required overall finesse of better than 150 necessitates manufacturing the plates with a defect finesse better than 220, which in turn requires a plate flatness in excess of $\lambda/300$ (at 630 nm).

This High Resolution Filter (HRF) is currently being manufactured and, once built, will be put through a complete environmental and performance qualification campaign. The HRF programme is expected to complete its manufacturing phase around the turn of the year proceeding to the test phase during February 2004. The

programme is scheduled for completion during June 2004.

Table 6: High resolution filter expected performance

Central Wavelength	935.5 nm
Working Aperture	50 mm
CSE Free Spectral Range	4 nm
CSE Plate Reflectivity	98.8 %
CSE Plate Flatness (target)	$\lambda/300$
CSE Plate Defect Finesse	220
CSE Plate Overall Finesse	160
Acceptance Angle	± 4 mrad
Transmission Bandwidth	25 pm
Overall Transmission	50 %
Tuning Range	9 nm
Background Rejection	10^{-5}

6. Future lidar instruments

As part of its activities to prepare for a long-term program in Earth Observation, the European Space Agency is now promoting studies with the objective to provide a background for and pave the way towards the definition of a spaceborne lidar systems to monitor greenhouse gases and also atmospheric pressure and temperature.

Several initiatives have been undertaken to assess the feasibility of monitoring CO₂ and other greenhouse gases by active optical sensors from space in the context of the Kyoto protocol. Proposals for missions have been made in the USA and Europe. The CELSIUS mission was proposed for implementation within the frame of NASA's ESSP. It would have used laser absorption spectroscopy (LAS) to obtain column integrated CO₂ densities. In order to meet the end objectives of an Integrated Carbon Observing System the measurement of concentration profiles would be very beneficial. The CARBOSAT mission was proposed as candidate to the second cycle of Earth Explorer Core Missions but not selected at the time for lack of technological maturity. It indeed proposed to use a challenging differential absorption lidar (pulsed) to obtain accurate profiles of CO₂ concentration.

The Agency is initiating system and instrument studies to first assess the potential to overcome the principle limitations of the existing passive sounding concepts by a Laser based instrument measuring the CO₂ column/profile. Instrument concept and performance will be derived. Another study is extending the range of applications to the monitoring of greenhouse gases as CO₂, CH₄, N₂O and also pressure and temperature profiles. The study is aiming at studying future lidar and DIAL concept. Instrument concepts will be derived and

a review of available technologies will be essential for the definition of the future main directions of the system, technology and pre-development activities for the next generation of lidar instruments.

Future technology development

Depending on their application Lidar's are based upon the use of the backscatter, Doppler effect, or differential absorption (DIAL). The systems can operate in a wide range of wavelength either in Continuous Wave, modulated or in pulsed mode, both coherent and incoherent.

In any case, the standard building blocks of a Lidar system are:

- Transmitter chain, including laser and pump laser
- Receiver chain, including filters, local oscillators (in case of a coherent system), detectors
- Optical system, including beam forming optics and transmit/receive telescopes
- Beam pointing system
- Control and data processing electronics
- Power supply
- Thermal control
- Structure

Those building blocks comprise generic technologies and instrument specific technologies. The main generic technology elements are:

- Detectors (CCD, APD, InGaAs detectors,...)
- High resolution filters (tunable, fixed...)
- Lasers and pump sources (tunable, fixed, local oscillators, power amplifiers,...)
- Optical systems (beam forming optics, large lightweight telescopes,...)
- Pointing systems (motors, encoders, bearings,...)
- Signal processors
- Modulators

The development of generic and instrument specific technologies as well as the definition of Lidar instrument concepts is tuned to the developing user requirements and, thus, performed in close dialogue with all user groups concerned.

The programmatic supporting the development of instrument specific technologies and instrument concepts is mainly driven by the short-term user needs. The generic technology developments, however, have to be defined taking into account long term technology trends that might prepare the development of future

system concepts and are, therefore, less driven by the short term planning considerations.

ESA is therefore initiating a range of technology development activities as part of its Technology Research Programme and Earth Observation instrument pre-developments. These activities are focussed on two main objectives: one, to develop advanced technologies to improve the performance or reduce the resource requirements of presently baselined lidar concepts, the second, to prepare advanced lidar concepts to cope with the forthcoming requirements and user needs for Atmospheric research, meteorology, climatology and environmental research. Figure 14 is summarizing the running and planned activities. The developments results will constitute a broad base to support the future programme implementation resulting from mission selection.

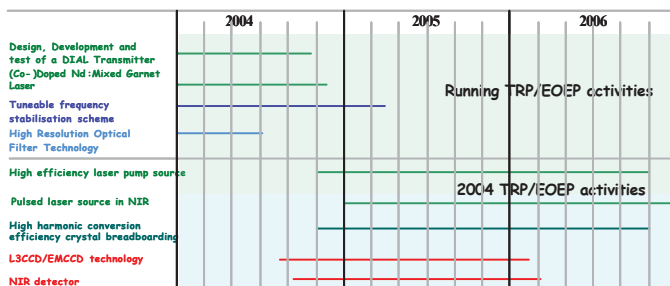

Figure 14: development planning for future lidar instruments

7. Acknowledgments

The authors would like to thank the industrial teams in charge of the fore-mentioned contracts and studies.

8. References

- [1] <http://www.esa.int/export/esaLP/aeolus.html>
- [2] WALES – Water Vapour Lidar Experiment in Space, Report for Assessment, ESA SP-1257 (2)
- [3] <http://unfccc.int/resource/convkp.html>
- [4] “The potential of spaceborne remote sensing to contribute to the quantification of anthropogenic emissions in the context of the Kyoto protocol”, Final Report of ESA contract 15427/01/NL/MM